

**Please, read this manual
carefully before use!**

Owner's Manual



Portable solar panel

KS SP28W-4

KS SP60W-3

KS SP90W-3

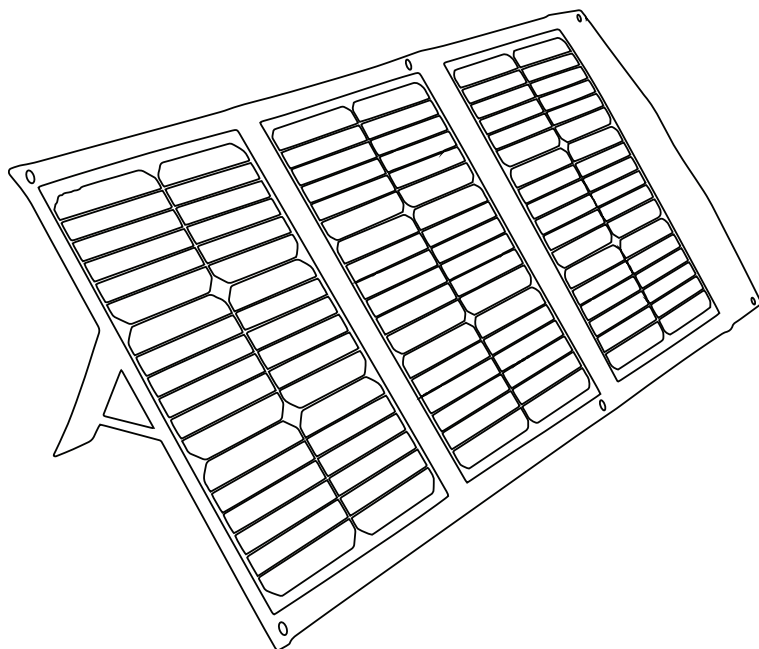



Thank you for your purchase of **Könnner & Söhnen®** products. This manual contains a brief description of safety, use and debugging. More information can be found on the official manufacturer's website in the support section: **konner-sohnen.com/manuals**

You can also go to the support section and download the full version of the manual by scanning the QR code, or on the website of the official importer of Könnner & Söhnen products: **www.konner-sohnen.com**



We care about the environment, therefore, we consider it expedient to save paper and leave in print a short description of the most important sections.



Be sure to read the full version of the manual before getting started!



Manufacturer reserves the right to make alterations into the generators, which may not be reflected in this manual. Pictures and photos of the product may vary from its actual appearance. At the end of this manual, You may find contact information which you are free to use in case of any issues occurrence.

All data, specified in this operation manual is the most up to date for the moment of its publishing. The current list of service centers you can find at the website of official importer: **www.konner-sohnen.com**



ATTENTION – DANGER!



Failure to follow the recommendations marked with this sign may lead to serious injury or death of the operator or third parties.



IMPORTANT!



Useful information while operating the machine.

This solar panel charger is compatible with cell phone, iPad, digital camera, PSP, GPS, power bank, power station and so on. It is suitable for any occasion where you can expose it to the sun. It is highly efficient in charging, easy you use, safe, environment-friendly, and energy-efficient.

PACKAGE CONTENTS

- 1 x Solar panel
- 1 x User manual
- 1 x Different DC Cables



ATTENTION – DANGER!



1. Please, do to hit, throw, prick the product, squeezing or bending the product and protect it from falling down to avoid irreversible damage.
2. Please, keep it away from humidity to ensure its long service life.
3. The actual power of a solar panel charger is affected by solar illumination, exposure angle and ambient temperature, so the difference between the nominal power and the actual power of solar panel charging is a normal phenomenon.
4. The intensity of sunlight must be high and the pane is should be as perpendicular to the light as possible.
5. When absorbing sunlight to charge, the solar panel surface must not be shadowed.

- Environment-friendly, practical and convenient for outdoor emergency power supply.
- Foldable design with portable size, easy to carry with just a single hand.
- The high-quality solar mono-crystalline silicon provides high charging efficiency and long service life.
- The product is compatible with the portable power stations. You can convert and store solar power in a battery of portable power stations in the day and charge devices at night. The portable solar panel kit includes an adapter with USB connectors, which can be used to charge mobile phones, tablets, power banks, etc.



NOTE



The portable power station should be purchased separately.

MAIN OVERVIEW

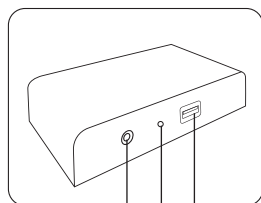

1 2 3

MODEL KS SP28W-4

1. DC 18V output
2. Indicator light
3. USB output

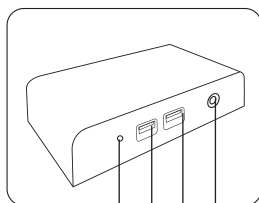

1 2 3 4

MODEL KS SP60W-3

1. Indicator light
2. USB output
3. USB QC 3.0 output
4. DC 18V output

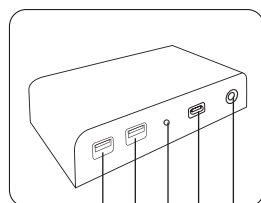

1 2 3 4 5

MODEL KS SP90W-3

1. USB output
2. USB QC 3.0 output
3. Indicator light
4. Type-C output
5. DC 18V output

3 folds: 21W/30W/60W/90W/120W

4 folds: 28W/40W/80W/100W

OUTPUT BOX

There may be some differences between different models. Please adhere to the actual product.

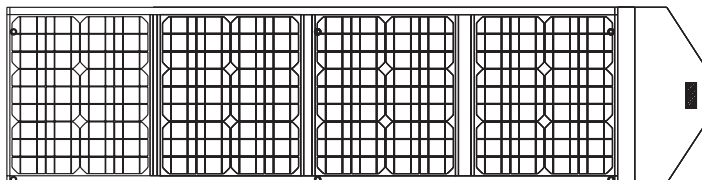
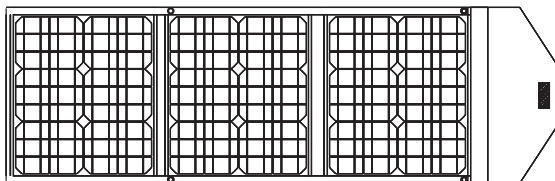



IMPORTANT!



Manufacturer reserves the right to make changes and/or improvements in design, components set and technical attributes without notice and without incurring obligation. The pictures in this manual are schematic and may not match the parameters of original product.

SPECIFICATIONS

4

Model	KS SP28W-4	KS SP60W-3	KS SP90W-3
Solar power	28W monocrystalline silicon (4pcs Panel)	60W monocrystalline silicon (3pcs Panel)	90W monocrystalline silicon (3pcs Panel)
Conversion efficiency	>20%	>20%	>20%
Solar panel output max.	max. 18V/1.55A	max. 18V/3.33A	max.18V/5A
USB Output	5V/2.4A	5V/2.4A	5V/2.4A
USB QC 3.0 Output	-	5V/3A, 9V/2A, 12V/1.5A	5V/3A, 9V/2A, 12V/1.5A
Type C Output	-	-	60W, 5V/3A, 9V/3A, 12V/2.5A, 15V/2A
Folded size (LxWxH), mm	290x200x29	399x355x28	520x370x45
Unfold size (LxWxH), mm	1050x290x4	1218x399x4	1280x520x4
Weight, kg	1.1	2.5	3.18
Operating Temperature	-20°C to 85°C	-20°C to 85°C	-20°C to 85°C
Delivery set	1 x 28W Solar panel 1 x DC-DC Connect cable 1 x Set of DC connectors 1 x Charger adapter with USB outputs	1 x 60W Solar panel 1 x DC-DC Connect cable 1 x DC-Anderson cable 1 x Set of DC connectors 1 x Charger adapter with USB outputs	1 x 90W Solar panel 1 x DC-DC Connect cable 1 x DC-Anderson cable 1 x Set of DC connectors 1 x Charger adapter with USB outputs

PRODUCT INSTRUCTION

5

HOW TO USE

1. Unfold the solar panel, expose it to sunlight, and connect the devices that need to be charged through the charger adapter.
2. Indicator: Red light indicates the adapter is receiving solar energy properly.

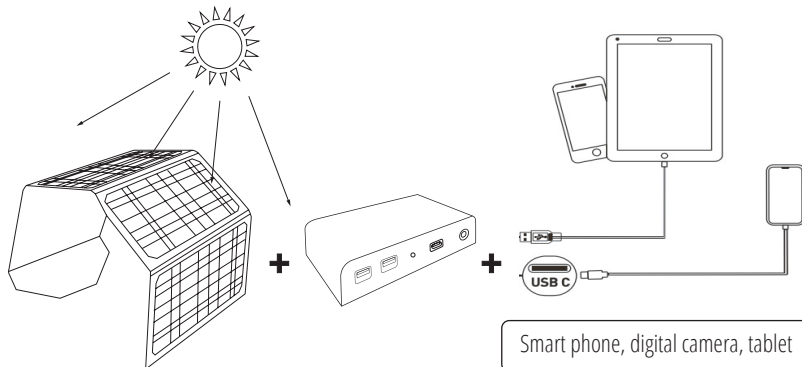

COMPATIBILITY

Compatible with most solar generators, with our included different sizes of connectors. The included DC-DC cable with 5.5 x 2.1 mm connectors is compatible with most portable power stations available on the market.

**NOTE**

The portable power station should be purchased separately.

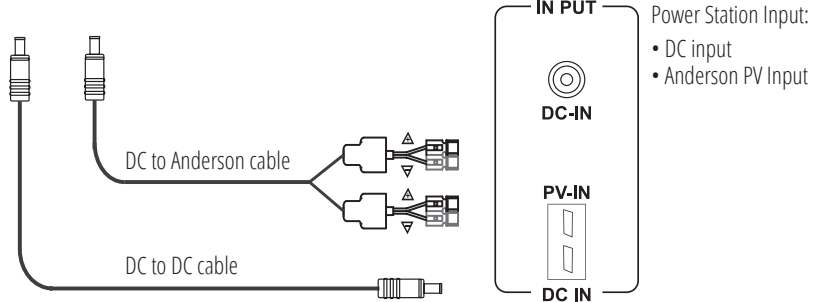
HOW TO CHARGE A PORTABLE POWER STATION:**TIPS****6**

1. Do not connect the charger adapter and the portable power station to the portable solar panel at the same time.
2. The charger adapter is not waterproof, do not allow moisture, rain, snow, etc. to get on it.
3. Please keep your device cool while charging.

QUESTIONS & ANSWERS**7****1. Does it have a battery or direct device charging?**

This item is without a battery, but you could use it to directly charge your devices.

2. How soon will it start charging?

It will start charging immediately under direct sunlight on the solar panel.

WARRANTY SERVICE TERMS**8**

The international manufacturer warranty is 1 year. The warranty period starts from the date of purchase. In cases when warranty period is longer than 1 year according to local legislation please contact your local dealer. The Seller which sells the product is responsible for granting the warranty. Please contact the Seller for warranty. Within the warranty period, if the product fails because of defects in the production process, it will be exchanged on the same product or repaired.

All faults caused by the manufacturer during the warranty period will be eliminated free of charge. Warranty repair is carried out only if you have a fully completed warranty card, the Buyer's signature of acceptance of the warranty terms, as well as a document supporting the purchase (cash receipt, sales slip or invoice). In the absence thereof, as well as in the event of errors or corrections not authenticated by the seller's seal or illegible inscriptions in the warranty card or tear-off coupon, no warranty repair is carried out, no objections to quality are accepted and the warranty card is withdrawn by the service center as invalid. The device is accepted for repair clean and full.



EC Declaration of Conformity

Nr. 127

The following products have been tested by us with the listed standards and found in compliance with the European Community Electromagnetic compatibility Directive (EMC) 2014/30/EC.

Manufacturer: DIMAX INTERNATIONAL GmbH
Address: Flinger Broich 203, 40235 Duesseldorf, Germany
Product: Portable solar panel "Könner & Söhnen"
Type / Model: KS SP28W-4, KS SP60W-3, KS SP90W-3

The statement is based on a single evaluation of above mentioned products. It does not imply an assessment of the whole production and does not permit the use of the test lab. logo. The manufacturer should ensure that all product in series production are in conformity with the product sample detailed in this report. The applicant should hold the whole technical report at disposal of the competent all the right.

Applied EC Directives: 2014/30/EC Electromagnetic compatibility Directive (EMC)
Directive 2011/65/EU (RoHS) as last amended by
Directive (EU) 2015/863

Applied Standards: EN IEC 61000-3-2:2019/A1:2021, EN 61000-3-3:2013+ A2:2021
EN 61000-4-2:2009, EN IEC 61000-4-3:2020,
EN 61000-4-4:2012, EN 61000-4-5:2014+A1:2017,
EN 61000-4-6:2014, EN 61000-4-8: 2010,
EN IEC 61000-4-11:2020
IEC 62321-5:2013, IEC 62321-4:2013+A1:2017,
IEC 62321-7-2:2017 , IEC 62321-6:2015 , IEC 62321-8:2017,
IEC 62321-3-1:2013 , IEC 62321-7-1:2015



Issued Date: 2022-06-20
Place of issue: Duesseldorf
General director: Fomin P. *P. Fomin*

DIMAX
International
GmbH
Steuer-Nr: 103 5722 2493
USt-Id-Nr: DE29617274

We DIMAX INTERNATIONAL GmbH hereby declare that specified above conforms covering European Parliament and Council Directives, Electromagnetic compatibility Directive (EMC) 2014/30/EC of 26 February 2014. The CE mark above can be used under the responsibility of manufacturer. After completion of an EC declaration of Conformity and compliance with all relevant EC directives.

CONTACTS

Deutschland:

DIMAX International GmbH
Flinger Broich 203 -FortunaPark-
40235 Düsseldorf, Deutschland
koenner-soehnen.com

Ihre Bestellungen

orders@dimaxgroup.de

Kundendienst, technische Fragen und Unterstützung

support@dimaxgroup.de

Garantie, Reparatur und Service

service@dimaxgroup.de

Sonstiges

info@dimaxgroup.de

Polska:

DIMAX International
Poland Sp.z o.o.

Polska, Warczawska,
306B 05-082 Stare Babice,
info.pl@dimaxgroup.de

Україна:

ТОВ «Техно Трейд КС»,
вул. Електротехнічна 47, 02222,
м. Київ, Україна

sales@ks-power.com.ua
