

Please, read this manual  
carefully before use!

Owner's Manual



## Cordless leaf blower & vacuum

KS LBV-40V

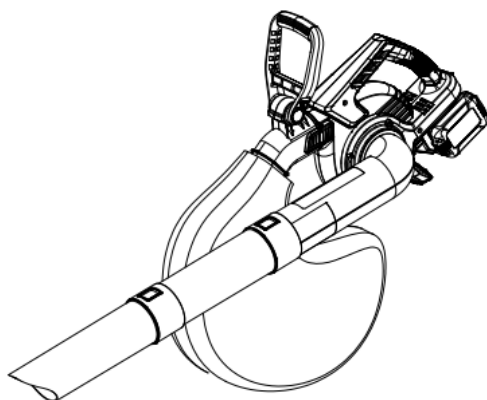
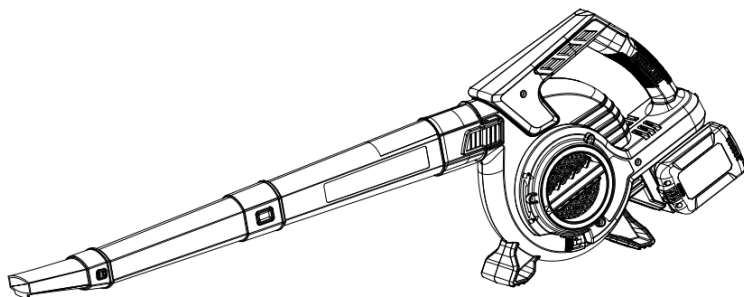



Thank you for opting for **Könner & Söhnen®** products. This manual contains a brief description of safety, setup and use. More information can be found on the official importer's website in the support section: [konner-sohnen.com/manuals](http://konner-sohnen.com/manuals)

You can also go to the support section and download the manual by scanning the QR code or on the website of the official importer of **Könner & Söhnen®** at [www.konner-sohnen.com](http://www.konner-sohnen.com)



*Please, read this manual carefully before use!*

The manufacturer of **Könner & Söhnen®** products reserves the right to make changes that may not be reflected in this manual, namely:

- The manufacturer reserves the right to make changes in the product design, configuration and construction.
- The images and drawings in this manual are for reference only and may differ from the actual components and inscriptions on the products.

Contact information that you are free to use in case of any problems can be found at the end of this manual. All information in this manual is correct to the best of our knowledge and belief at the date of its publication. The current list of service centers can be found on the official importer's website at [www.konner-sohnen.com](http://www.konner-sohnen.com)



**ATTENTION – DANGER!**



**Failure to follow the recommendations marked with this sign may lead to serious injury or death of the operator or third parties.**



**IMPORTANT!**









**Useful information while operating the machine.**

## SAFETY WARNINGS

1

1. Carefully read and understand all safety instructions and precautions in this user manual before using your cordless leaf blower & vacuum.
2. This leaf blower & vacuum is designed and intended for household use only. It is not intended for industrial or commercial use.
3. Before each use, carefully inspect the leaf blower & vacuum for any visible damage to ensure that it is in good working condition. Do not use the leaf blower & vacuum if you notice any malfunctions.
4. Avoid using your leaf blower & vacuum to pick up the following objects or substances:
  - water, flammable liquids and other liquid materials;
  - burning cigarette butts, smoldering charcoal or ashes, other burning or hot objects;
  - sharp or dangerous items that could damage the vacuum cleaner or endanger the user;
  - particles of wood, gypsum, putty, cement, lime, or other hard materials that may get compacted in the leaf blower & vacuum and cause damage.
5. Keep the leaf blower & vacuum away from stoves, heaters and other heat sources. Exposure to heat can deform and discolor the plastic parts of the leaf blower & vacuum.
6. Never leave the leaf blower & vacuum unattended while it is running. Keep the unit out of the reach of children.
7. Always disconnect the leaf blower & vacuum remove the battery before cleaning, attempting any maintenance task, fitting or removing accessories. This prevents unintentional power-on and ensures safety during maintenance.

8. Never use alcohol or other solvents to clean the unit.
9. If the leaf blower & vacuum generates any abnormal noise, odor or smoke, power it off immediately, remove the battery and have the leaf blower & vacuum inspected or repaired at an authorized service center.
10. Before disposing of the unit, remove the battery and observe local laws and regulations regarding disposal of lithium-ion batteries. Never dispose of the battery with household waste.
11. Use the attachments and accessories supplied with your leaf blower & vacuum for their intended purpose. Improper use of the tools and nozzles may endanger the user and damage the unit.

	Guarantee sound power level.
	Do not expose to rain and humidity.
	Beware of falling objects. Keep bystanders away.
	Keep bystanders at least 15 m away.
	Failure to follow the recommendations marked with this sign may lead to serious injury or death of the operator or third parties.
	Wear personal protective equipment. Basically, wear protective goggles or, even better, face protection, ear protection, safety helmet, cut-protection working clothes, cut-protection safety boots with anti-slip soles.

## MAIN OVERVIEW

2



**IMPORTANT!**



**Manufacturer reserves the right to make changes and/or improvements in design, components set and technical attributes without notice and without incurring obligation. The pictures in this manual are schematical and may not match the parameters of original product.**

- |   |  |
|---|--|
| 1. Motor housing  | 8. Left battery (not included)           |
| 2. Handle   | 9. Right battery (not included)          |
| 3. Protective cover, suction aperture                         | 10. Collection bag carabiner             |
| 4. Button for disassembling suction pipe and protective cover | 11. Collection bag                       |
| 5. Blow pipe  | 12. Suction pipe                         |
| 6. Locking button for blowing aperture                        | 13. Angle adjuster for additional handle |
| 7. Additional handle  | 14. Intelligent control panel            |

### UNPACKING

Unpack the power tool and all its parts, and compare against the list below. Do not discard the carton or any packaging materials.

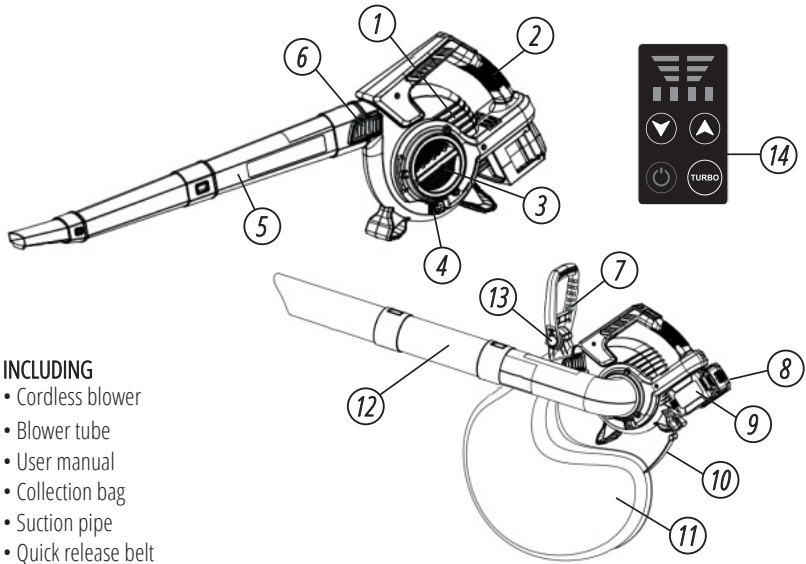

**INCLUDING**

- Cordless blower
- Blower tube
- User manual
- Collection bag
- Suction pipe
- Quick release belt

**SPECIFICATIONS**

3

Model	KS LBV-40V
Rated voltage	40V (20V+20V)
Max no-load speed	16300 rpm
Max air speed	270 km/h
Max wind capacity	550 m <sup>3</sup> /h
Speed selection	4 speeds + "Turbo" mode
Collection bag	45 l
Gross dimensions (L×W×H)	470×280×360 mm
Gross/Net weight	4.6/3.5 kg

**ASSEMBLY INSTRUCTION**

3



ATTENTION – DANGER!



If any parts are damaged or missing do not operate this product until the parts are replaced. Use of this product with damaged or missing parts could result in serious personal injury.



ATTENTION – DANGER!



Do not connect to batteries until assembly is complete. Failure to comply could result in accidental starting and possible serious personal injury.

**ASSEMBLING/ DISASSEMBLING THE THREE PIECE BLOWPIPE**



ATTENTION – DANGER!



Never use the leaf blower with only one blowpipe section attached. There is a risk of personal injury!

- Assemble the three-piece blowpipe (5) as illustrated (Fig.2). The parts can be felt to lock into place.
- Now push the blowpipe (5) on to the blowing aperture of the motor housing (1) until the blowpipe (5) latches into place.(Fig. 3).
- Dismantle the blowpipe (5) by pressing the locking button (6) and pulling off the blowpipe.

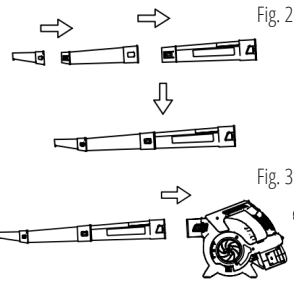

**ASSEMBLING/DISASSEMBLING THE THREE PIECE SUCTION PIPE**

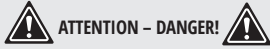

**ATTENTION - DANGER!**

**Never use the leaf blower with only one suction pipe attached. There is a risk of personal injury!**

- Open the protective cover (3) of the suction aperture by pressing the locking of the suction aperture (4) in the direction of the suction aperture and pulling out the protective cover, turning it clockwise until it stops. You can now remove the protective cover (3). (Fig.4)
- Assemble the three suction pipes as illustrated (Fig 5).
- When assembling, pay attention to the guide grooves on the suction pipe parts.
- Place the suction pipe (12) on the suction aperture, as in fig.6 (below). Turn the suction pipe anticlockwise until it stops. Push the suction pipe into the motor housing until it clicks into place.
- Dismantle the suction pipe (12) by pressing the lock of the suction aperture (4) in the direction of the suction aperture and pulling out the suction pipe, turning it clockwise until it stops. You can now remove the suction pipe.

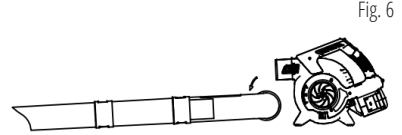
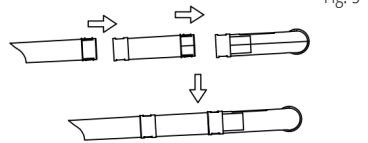
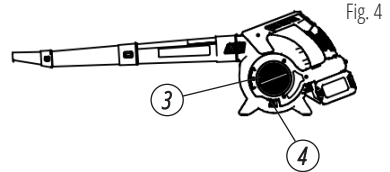

**INSTALLING /REMOVING THE COLLECTION BAG**



**ATTENTION - DANGER!**

**In suction mode the device must only be operated with the collection bag mounted. The ventilation opening on the collection bag (11) serves for an improved air circulation.**

- If necessary, remove the blowpipe (5) (see “Assembling/dismantling the three-piece blowpipe”).
  - Now push the collection bag (11) on to the blowing aperture of the motor housing (1) until it latches with the locking button (6).
  - Hook the carabiner (10) of the collection bag into the eyelets provided on the motor housing.
- The additional handle (7) can be locked in various positions.
- Press the angle adjuster (13) on the additional handle (7).
  - Adjust the additional handle to the desired position.
  - Release the angle adjuster (13).

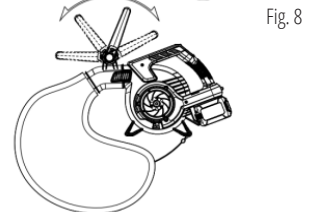
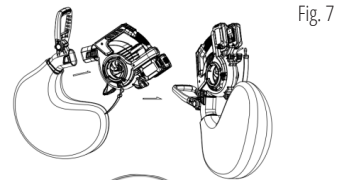

## PUTTING ON THE CARRING BAG



**ATTENTION – DANGER!**



**Never wear the carrying strap diagonally across your shoulders and chest: only wear it on one shoulder to ensure you can detach the device quickly from your body in the event of danger.**

- Place the carrying strap on one shoulder.
- Adjust the strap length so that the snap hook is approximately 10 cm below your hip.
- Attach the snap hook on the eyelet to insert the strap.

## CONNECTING AND REMOVING BATTERY

4

### TO INSTALL THE BATTERY PACK

To install the battery pack into the bottom of the handle, align the rails of the battery pack with the rails in the handle and push the battery into the handle. To connect the battery, slide the battery pack fully forward. Until the latch locks into place.

### TO REMOVE THE BATTERY PACK

Press the battery release button, Slide the battery pack backward, and then pull or lift the battery out of the tool.



**WARNING!**



**Follow these instructions in order to avoid injury and to reduce the risk of electric shock or fire:**

- **Replace the battery pack or the charger immediately if the battery case or charger cord is damaged.**
- **Verify that the battery pack is removed before inspecting, adjusting, or performing maintenance on any part of the power tool.**
- **Read, understand, and follow the instructions.**

### THE CONTROL PANEL

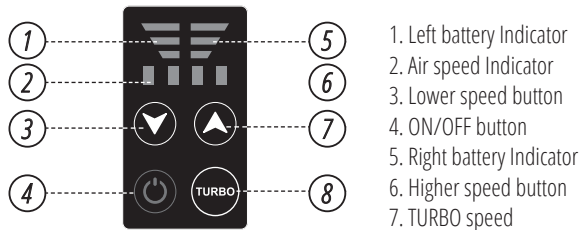

### TO KNOW THE BATTERY CAPACITY

Left battery indicator show the capacity of left side battery. Right battery indicator show the capacity of right side battery. When battery is full charged, it's with green color. When battery is half capacity, it's with yellow color. When battery is not enough capacity, it's with red color. When you see the red color, you need charge the battery.

### TO KNOW AND CONTROL AIR SPEED

Air speed indicator shows four different air speed during your job. You can press the lower speed button to lower the air speed, or press higher speed button to higher the air speed. The air speed indicator will show which speed you are working.

### TURBO BUTTON

A function of increase in airflow "turbo" , is used only on occasions when leaves and trash is stuck or when the normal airflow is not sufficient . In most cases , normal airflow is sufficient. An increase in airflow is used mainly for brief measures.

### SWITCHING ON/OFF

Hold the blower with one hand on the control handle - wrap your thumb around the handle.

Pull the trigger with your index finger and hold it there. The blower accelerates and air flows from the nozzle.

To switch off, release the On/Off trigger switch. No air flows from the nozzle.

### USING THE BLOWER

Handling and Controlling the Blower

Hold and control the blower with one hand on the control handle - wrap your thumb around the handle.

Point the nozzle at the ground, walk slowly and steadily forwards.

### USING THE SUCTION

Always hold the device tight with both hands during operation: use the handle and the additional handle for this.

Make sure the volumes of leaf material sucked in at one time are not too large. This will avoid clogging of the suction tube and blockage of the impeller wheel.

### EMPTYING THE COLLECTION BAG

With full collection bag, the suction pumping capacity decreases considerably and the collection bag must be emptied when the bag is full or interferes with the suction capacity of the device.

- a) Turn off the device and wait until the impeller has stopped.
- b) Remove the batteries from the device (see "Removing/inserting the battery").
- c) Remove the carabiner from the eyelets. Release the collection bag by pressing the locking button.
- d) Open the zip-fastener on the collection bag and empty it completely.
- e) Mount the emptied collection bag again.

### TEMPERATURE CONTROL /OVERLOAD PROTECTION

When the temperature of battery is too high and the machine switches off automatically.

- Switch the power tool off.
- Allow the battery to cool down before continuing to work. When the power tool is blocked and switches off automatically.
- As soon as the blockage is corrected, the tool will continue to work at the set stroke rate.



ATTENTION – DANGER!

**In order to avoid personal injury and the risk of fire and electric shock, remove the battery pack before adjusting, inspecting, or cleaning the power tool.**



ATTENTION – DANGER!

**When servicing, use only identical replacement parts. Use of any other parts could create a hazard or cause product damage.**

- Be alert for battery packs that are nearing their end of life. If you notice decreased tool performance or significantly shorter running time between charges then it is time to replace the battery pack. Failure to do so can cause the tool to operate improperly or damage the charger.

- Ventilation openings and switch levers must be kept clean and free of foreign matter. Do not attempt to clean by inserting pointed objects through opening.
- Avoid using solvents when cleaning plastic parts. Most plastics are susceptible to damage from various types of commercial solvents and may be damaged by their use. Use clean clothes to remove dirt, oil, grease, etc.

## WARRANTY SERVICE TERMS

7



**ATTENTION – DANGER!**



**Read instruction manual first! Remove battery pack from the tool before making adjustments or assembling accessories.**

Problem	Possible cause	Possible solution
Unit will not start.	Battery pack not installed properly.	Check battery pack installation.
	Battery pack not charged.	Check battery pack charging requirements.
Unit shuts off abruptly.	Battery pack has reached its maximum thermal limit.	Allow battery pack to cool down.
	Out of charge. (To maximize the life of the battery pack, it is designed to shutoff abruptly when the charger is depleted.	Place on charger and allow to charge.
Impeller does not move.	Foreign body blocking the impeller.	Remove the blockage.

## WARRANTY SERVICE TERMS

8

The international manufacturer warranty is 1 year. The warranty period starts from the date of purchase. In cases when warranty period is longer than 1 year according to local legislation please contact your local dealer. The Seller which sells the product is responsible for granting the warranty. Please contact the Seller for warranty. Within the warranty period, if the product fails because of defects in the production process, it will be exchanged on the same product or repaired.

All faults caused by the manufacturer during the warranty period will be eliminated free of charge. Warranty repair is carried out only if you have a fully completed warranty card, the Buyer's signature of acceptance of the warranty terms, as well as a document supporting the purchase (cash receipt, sales slip or invoice). In the absence thereof, as well as in the event of errors or corrections not authenticated by the seller's seal or illegible inscriptions in the warranty card or tear-off coupon, no warranty repair is carried out, no objections to quality are accepted and the warranty card is withdrawn by the service center as invalid. The device is accepted for repair clean and full.



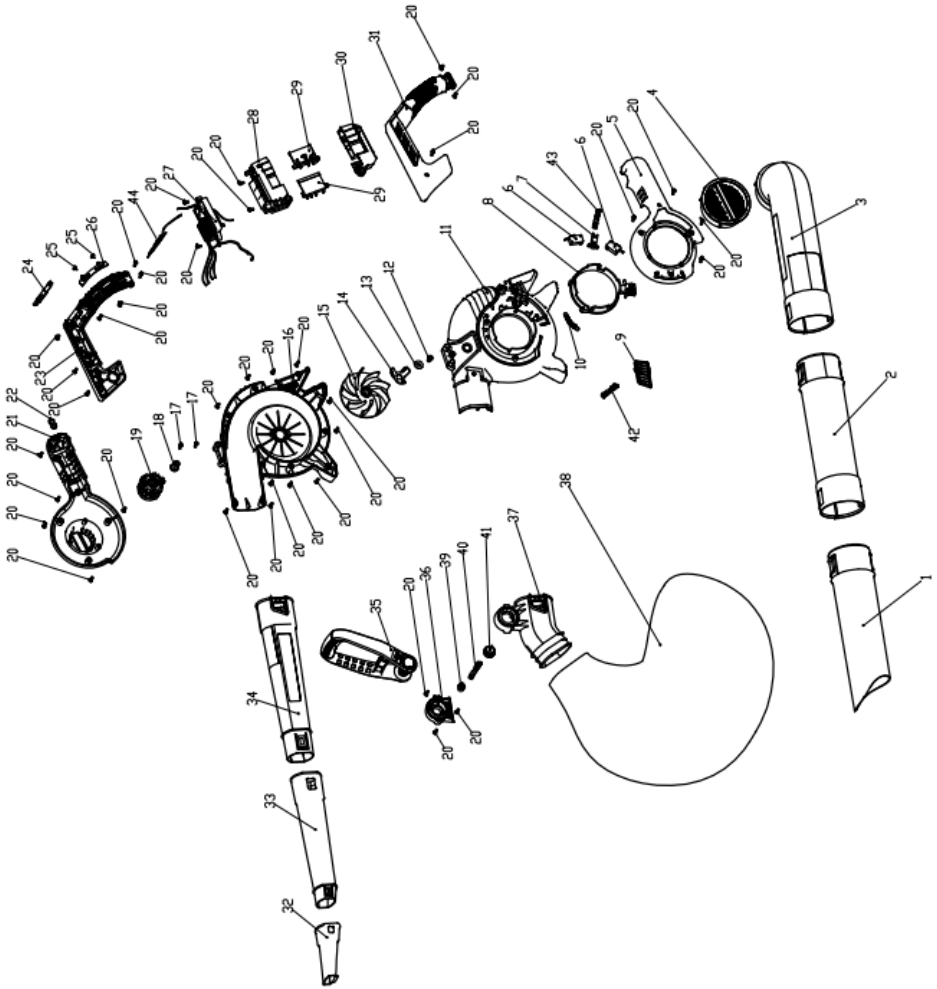

Item	Description	Qty
1	Front blow pipe	1
2	Middle blow pipe	1
3	Rear blow pipe	1
4	Suction cover	1
5	Left housing cover	1
6	Mirco switch	2
7	Switch button	1
8	Rotation circle	1
9	Blow pipe button	1
10	Tension spring	1

Item	Description	Qty
11	Left housing	1
12	Screw	1
13	Washer	1
14	Blade	1
15	Fan	1
16	Right housing	1
17	Screw	2
18	Shaft sleeve	1
19	Motor assy	1
20	Screw	39

Item	Description	Qty
21	Right housing cover	1
22	Belt hanger	1
23	Right handle	1
24	Panel	1
25	Screw	2
26	Antistatic panel	1
27	PCB	1
28	Upper battery base	1
29	Insert base assy	2
30	Down battery base	1
31	Left handle	1
32	Blow mouth	1

Item	Description	Qty
33	Small blow pipe	1
34	Big blow pipe	1
35	Front handle	1
36	Support base	1
37	Collection bag sleeve	1
38	Collection bag	1
39	Handle button	1
40	Front handle button spring	1
41	Front handle button	1
42	Spring	1
43	Spring	1
44	Battery volume panel	1



# EC Declaration of Conformity

Nr. 181

The following products have been tested by us with the listed standards and found in compliance with the European Community Directive 2014/30/EU relating to electromagnetic compatibility, Directive 2006/42/EC relating to machinery.

Manufacturer: DIMAX INTERNATIONAL GmbH  
Address: Flinger Broich 203, 40235 Duesseldorf, Germany  
Product: Cordless leaf blower & vacuum "Könner & Söhnen"  
Type / Model: KS LBV-40V

The statement is based on a single evaluation of above mentioned products. It does not imply an assessment of the whole production and does not permit the use of the test lab. logo. The manufacturer should ensure that all product in series production are in conformity with the product sample detailed in this report. The applicant should hold the whole technical report at disposal of the competent all the right.

Applied EC Directives: 2014/30/EU Electromagnetic compatibility Directive (EMC)  
2006/42/EC Machinery Directive

Applied Standards: EN 60335-1:2012/A2:2019  
EN 50636-2-100:2014  
EN ISO 12100:2010  
EN 62233:2008  
EN 55014-1:2017  
EN 55014-2:2015  
AfPS GS 2019:01 PAK  
EK9-BE-91(v4):2020

## 2000/14/EC\_2005/88/EC Annex VI

For model KS LBV-40V Noise measured Lwa = 97 dB (A), guaranteed Lwa = 100 dB (A)



**Issued Date:** 2024-02-08  
**Place of issue:** Duesseldorf  
**Director:** Fomin P.

*P. Fomin*

## DIMAX

International GmbH  
Flinger Broich 203 40235 Düsseldorf  
USt-ID DE296177274  
koenner-soehnen.com

We DIMAX INTERNATIONAL GmbH hereby declare that specified above conforms covering European Parliament and Council Directives, 2006/42/EC of 17 May 2006 Machinery Directive, Electromagnetic compatibility Directive (EMC) 2014/30/EC of 26 February 2014. The CE mark above can be used under the responsibility of manufacturer. After completion of an EC declaration of Conformity and compliance with all relevant EC directives.

## CONTACTS

### **Deutschland:**

DIMAX International GmbH  
Flinger Broich 203 -FortunaPark-  
40235 Düsseldorf, Deutschland  
[www.koenner-soehnen.com](http://www.koenner-soehnen.com)

### **Ihre Bestellungen**

[orders@dimaxgroup.de](mailto:orders@dimaxgroup.de)

### **Kundendienst, technische Fragen und Unterstützung**

[support@dimaxgroup.de](mailto:support@dimaxgroup.de)

### **Garantie, Reparatur und Service**

[service@dimaxgroup.de](mailto:service@dimaxgroup.de)

### **Sonstiges**

[info@dimaxgroup.de](mailto:info@dimaxgroup.de)

---

### **Polska:**

DIMAX International  
Poland Sp.z o.o.

Polska, Warszawska,  
306B 05-082 Stare Babice,  
[info.pl@dimaxgroup.de](mailto:info.pl@dimaxgroup.de)

---

### **Україна:**

ТОВ «Техно Трейд КС»,  
вул. Електротехнічна 47, 02222,  
м. Київ, Україна

[sales@ks-power.com.ua](mailto:sales@ks-power.com.ua)

---