

**Please, read this manual
carefully before use!**

Owner's Manual



Jump starter with air compressor

KS JSP-1300

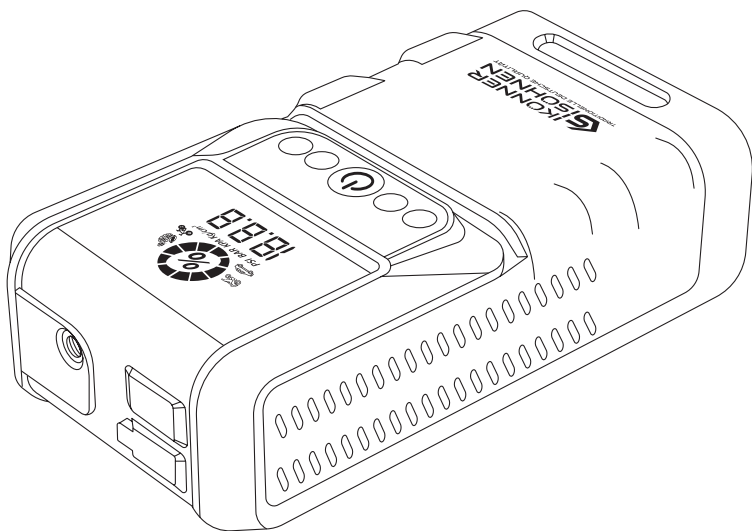



Thank you for opting for **Könnert & Söhner®** products. This manual contains a brief description of safety, setup and use. More information can be found on the official importer's website in the support section: **konner-sonnen.com/manuals**

You can also go to the support section and download the manual by scanning the QR code or on the website of the official importer of Könnert & Söhner® products: **www.konner-sonnen.com** (for Europe), **uk.konner-sonnen.com** (for the UK), **www.konner-sonnen.com/en-us** (for the USA).



(for Europe)



(for UK)



(for USA)

Please, read this manual carefully before use!

The manufacturer of **Könnert & Söhner®** products reserves the right to make changes that may not be reflected in this manual, namely:

- The manufacturer reserves the right to make changes in the product design, configuration and construction.
- The images and drawings in this manual are for reference only and may differ from the actual components and inscriptions on the products.

Contact information that you are free to use in case of any problems can be found at the end of this manual. All information in this manual is correct to the best of our knowledge and belief at the date of its publication. The current list of service centers can be found on the official importer's website: **www.konner-sonnen.com** (for Europe), **uk.konner-sonnen.com** (for the UK), **www.konner-sonnen.com/en-us** (for the USA).



ATTENTION – DANGER!



Failure to follow the recommendations marked with this sign may lead to serious injury of the operator or third parties.



IMPORTANT!



Useful information while operating the machine.

JUMP STARTER WITH AIR COMPRESSOR

1

Jump starter has following functions



Jump starter



Device charging function



Cordless air compressor



Flashlight function

Jump starter KS JSP-1300 can instantly start 12V vehicles up to 9.0-Liter gasoline or 5.0-Liter diesel engines. To avoid safety risks, please do not jump start the car with an unsuitable low capacity.

MAIN OVERVIEW

2



IMPORTANT!



Manufacturer reserves the right to make changes and/or improvements in design, components set and technical attributes without notice and without incurring obligation. The pictures in this manual are schematic and may not match the parameters of original product.

1. LED lights
2. DC connector/Output for connecting the terminals of the jump starter
3. Air hose connector
4. Pressure up
5. Pressure down
6. Mode selection
7. LED Switch
8. Power switch/ Air compressor switch
9. Display Screen
10. Charging port: 5V/3A, 9V/2A, 12V/1.5A
11. USB1: 5V/3A, 9V/2A, 12V/1.5A
12. USB2: 5V/3A, 9V/2A, 12V/1.5A

THE PACKAGE INCLUDES:

- Jump starter
 - Packaging
 - Operating instruction
13. Accessories storage bag
 14. USB charging cable
 15. Smart clamp
 16. Nozzle adapters
 17. Air hose

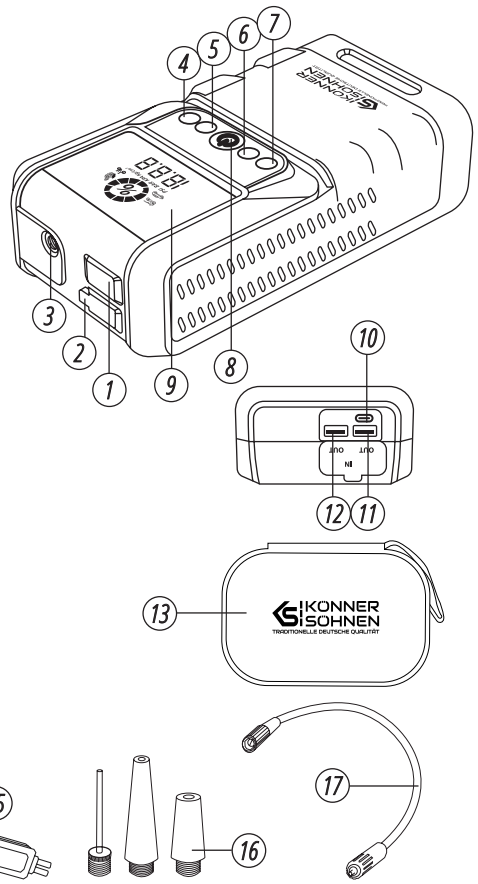

TECHNICAL SPECIFICATION

3

Model KS JSP-1300 parameters	Value
Battery	16000 mAh
Max. pneumatic pressure	150 PSI (10.3 BAR)
Speed	16500 rpm
Max air volume	26 L/min
The tire pressure accuracy	±0.1 bar
USB Output	2× 5V/3A, 9V/2A, 12V/1.5A
Type-C Input	5V/3A, 9V/2A, 12V/1.5A
Rated starting current	650 A
Peak current	1300 A
Charging time	4-5 hours
Net dimensions (LxWxH)	205×105×58 mm
Net weight	1.35 kg
Operating temperature	(-20 °C) – (+60 °C)

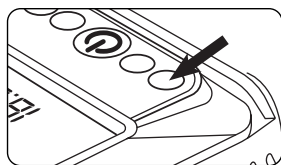

HOW TO USE LED EMERGENCY LIGHTING

Press and hold the key for 3 seconds to turn on the flashlight, then the light button function changes from solid light to flashing, SOS distress signal light. Press and hold button again for three seconds to turn off the flashlight.

HOW TO START A CAR WITH A FLAT BATTERY:



WARNING!



The device is suitable only for 12V batteries!

When starting the car, please confirm that the power of the product is more than 20%.

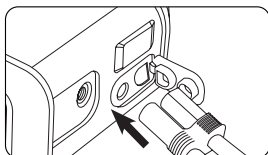

STEP 1: Open the silicone stopper of the product and insert the battery clamp into the corresponding hole of the product.

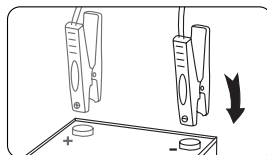

STEP 2: Connect the battery clamp to the positive and negative poles of the car battery (Red for the positive terminal and black for the negative terminal).

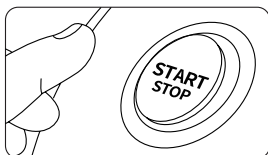

STEP 3: Start the engine. Do not cycle the jump starter for more than 3 seconds, pause for 1 minute between jump start attempts. This is necessary to let the jump starter battery cool down.

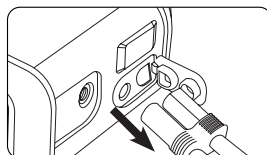

STEP 4: The plug is withdrawn from the jump starter first, and then the battery clips are removed from the positive and negative terminals.

When the connection is successful, the indicator lights up green.

The red light indicates that the supply voltage is too low or that the positive and negative electrode terminals have been swapped.

DEVICE CHARGING FUNCTION:

Plug the USB charging cable into the product USB (5V/3A, 9V/2A, 12V/1.5A) interface. Plug the other end of the charging cable into the corresponding interface of the mobile phone or digital product. After connecting the cable, press the Power switch(8) to start power supply.

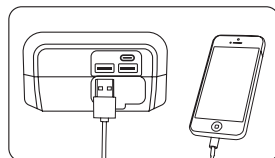
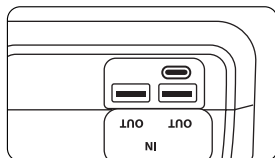

The device is protected against overheating. If the device gets overheated, the red indicator light will be on continuously, and the buzzer will emit 2 beeps per second. Once the fault has been rectified, the buzzer will return to normal status. Overtemperature protection is triggered at 80 °C.

The device features protection against overcurrent. If the protection is triggered, the device will automatically shut down, the protection indicator will light up, and the buzzer will emit 4 beeps per second. After the fault has been rectified, the indicator will immediately return to normal status.

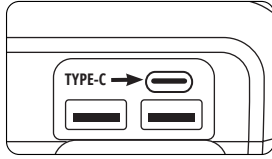

It is recommended that you use an AC adapter with an output of at least 5V/1A or preferably 5V/3A for charging. It can be a smartphone or tablet charger.

Insert the matching adapter and charger plug into the USB Type-C input port of the product.

AIR COMPRESSOR FUNCTION

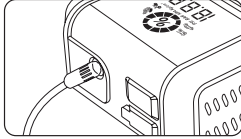

Connect one end of the inflation line to the air hole.

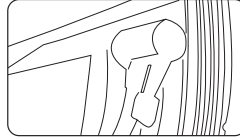

Connect one end of the inflation cable to the tire.

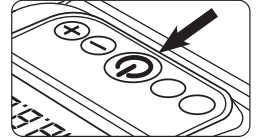

Press the power button for 2 seconds to enter the inflation mode (digital flashing).

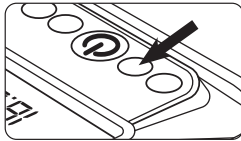

Select the mode.

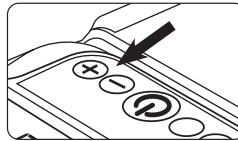

“+,” “-” button to adjust the pressure (the host has set the general value, can be default or adjusted).

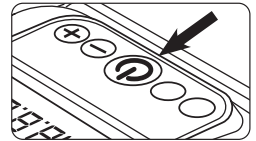

Press the power button to start inflating. Press the power button for 2 seconds to shut down, or it will automatically shut down after 30 seconds.

WARNING

5

1. Read the operating instructions carefully before using the device.
2. The device must never be used as a substitute for a car battery.
3. Keep children and animals away from the working area of the device.
4. Only use the jump starter for 12 V batteries.
5. Keep the clips and their connection points clean and tidy. Never connect the clips together.
6. Avoid using the device near explosive substances, flammable gases, or in dusty environments.
7. Avoid overheating the device, smoking near the device, and exposing the device to extreme moisture; keep the device away from open flames and never immerse it in water.
8. The device must not be stored at temperatures exceeding 60 °C.
9. After successfully jump-starting the vehicle, disconnect the jump starter from the battery within 30 seconds to prevent equipment damage.
10. Do not use the jump starter cable to charge other devices.
11. Keep it supervised while charging.
12. Using the device at current and voltage ranges other than those specified on the device nameplate may cause charging and discharging problems and deterioration of battery capacity and performance. This is also dangerous and may cause the device to malfunction.

13. When the battery is stored for more than three months, the product needs to be charged to ensure the normal performance of the product.
14. Never do anything that may cause mechanical damage to the device.
15. Do not disassemble or transform the product without authorization.
16. If the device casing is bulged, leaking, or giving off an unpleasant odor, stop using the device immediately.
17. If you notice battery acid leaking from the battery, do not touch it with bare hands. If battery acid contacts the skin or eyes, rinse immediately with plenty of running cold water and soap. Flush eyes for at least 10 minutes. Seek medical advice if necessary.
18. The device features a lithium rechargeable battery that must be disposed of under the applicable laws in your country.
19. Please connect the starting cable correctly according to the manual.
20. Never attempt to jump-start the vehicle in continuous mode! With standard power, the start cycle should take no more than 3 seconds, and the interval between cycles should be at least 1 minute. Do not exceed 3 consecutive start attempts.
21. After starting the car with the jump starter, the temperature of the jump starter itself will rise. Please do not charge the jump starter at this time; wait at least 8-10 minutes before charging.
22. Only use the jump starter cable supplied with the jump starter.
23. Do not charge the device immediately after jump-starting the vehicle's battery.
24. Never use the device to start the vehicle's battery and charge the device's internal battery simultaneously.

WARRANTY SERVICE TERMS

6

The term and conditions of the warranty may differ depending on the country where the product was purchased.

You can familiarize yourself with the terms of warranty service in the electronic version of the manual by scanning the QR code:



(for Europe)



(for UK)



(for USA)



EC Declaration of Conformity

Nr. 199

The following products have been tested by us with the listed standards and found in compliance with the European Community Electromagnetic compatibility Directive (EMC) 2014/30/EC.

Manufacturer: DIMAX INTERNATIONAL GmbH
Address: Flinger Broich 203, 40235 Duesseldorf, Germany
Product: Jump starter with air comprssor "Könner & Söhnen"
Type / Model: KS JSP-1300

The statement is based on a single evaluation of above mentioned products. It does not imply an assessment of the whole production and does not permit the use of the test lab. logo. The manufacturer should ensure that all product in series production are in conformity with the product sample detailed in this report. The applicant should hold the whole technical report at disposal of the competent all the right.

Applied EC Directives: 2014/30/EU Electromagnetic compatibility Directive (EMC)
EU RoHS 11/65/EU
2015/863/EU

Applied Standard: EN IEC 61000-6-3:2021
EN IEC 61000-6-1:2019
IEC 62321-3-1:2013
IEC 62321-5:2013
IEC 62321-4:2013+AMD1:2017
IEC 62321-7-2:2017
IEC 62321-7-1:2015
IEC 62321-6:2015
IEC 62321-8:2017



Issued Date: 2024-08-01
Place of issue: Duesseldorf
Director: Fomin P.

DIMAX
International GmbH
Flinger Broich 203 40235 Düsseldorf
USt-ID DE296177274
koenner-soehnen.com

P. Fomin

We DIMAX INTERNATIONAL GmbH hereby declare that specified above conforms covering European Parliament and Council Directives, Electromagnetic compatibility Directive (EMC) 2014/30/EC of 26 February 2014. The CE mark above can be used under the responsibility of manufacturer. After completion of an EC declaration of Conformity and compliance with all relevant EC directives.

CONTACTS

Deutschland:

DIMAX International GmbH Flinger
Broich 203 -FortunaPark- 40235
Düsseldorf, Deutschland
www.konner-sohnen.com

Ihre Bestellungen

orders@dimaxgroup.de

**Kundendienst, technische Fragen
und Unterstützung**

support@dimaxgroup.de

Garantie, Reparatur und Service

service@dimaxgroup.de

Sonstiges

info@dimaxgroup.de

The United Kingdom:

Innovation Trade Ltd.,
63/66 Hatton Garden Fifth Floor,
Suite 23, London, EC1N 8LE
info.uk@dimaxgroup.de

Technical support

support.uk@dimaxgroup.de

The United States:

KS Energy Solutions, Inc.
Balcones Drive STE 100 Austin,
TX 78731, USA

Authorized Warranty Service

support.us@dimaxgroup.com

www.konner-sohnen.com/us

Polska:

DIMAX International Poland Sp.z o.o.
ul. Południowa 8, 05-830,
Stara Wieś, Polska,
info.pl@dimaxgroup.de
www.konner-sohnen.com

Україна:

ТОВ «Генератор Альянс»,
вул. Електротехнічна 47,
02225, м. Київ, Україна
sales@ks-power.com.ua
www.konner-sohnen.com